

Technology Brief 9: Capacitive Sensors

To sense is to respond to a stimulus. (See Tech Brief 7 on resistive sensors.) A capacitor can function as a sensor if the stimulus changes the capacitor's **geometry**—usually the spacing between its conductive elements—or the effective **dielectric properties** of the insulating material situated between them. Capacitive sensors are used in a multitude of applications. A few examples follow.

Fluid Gauge

The two metal electrodes in [Fig. TF9-1(a)], usually rods or plates, form a capacitor whose capacitance is directly proportional to the **permittivity** of the material between them. If the fluid section is of height h_f and the height of the empty space above it is $(h - h_f)$, then the overall capacitance is equivalent to two capacitors in parallel, or

$$C = C_f + C_a = \epsilon_f w \frac{h_f}{d} + \epsilon_a w \frac{(h - h_f)}{d},$$

where w is the electrode plate width, d is the spacing between electrodes, and ϵ_f and ϵ_a are the permittivities of the fluid and air, respectively. Rearranging the expression as a linear equation yields

$$C = kh_f + C_0,$$

where the constant coefficient is $k = (\epsilon_f - \epsilon_a)w/d$ and $C_0 = \epsilon_a wh/d$ is the capacitance of the tank when totally empty. Using the linear equation, the fluid height can be determined by measuring C with a bridge circuit [Fig. TF9-1(b)].

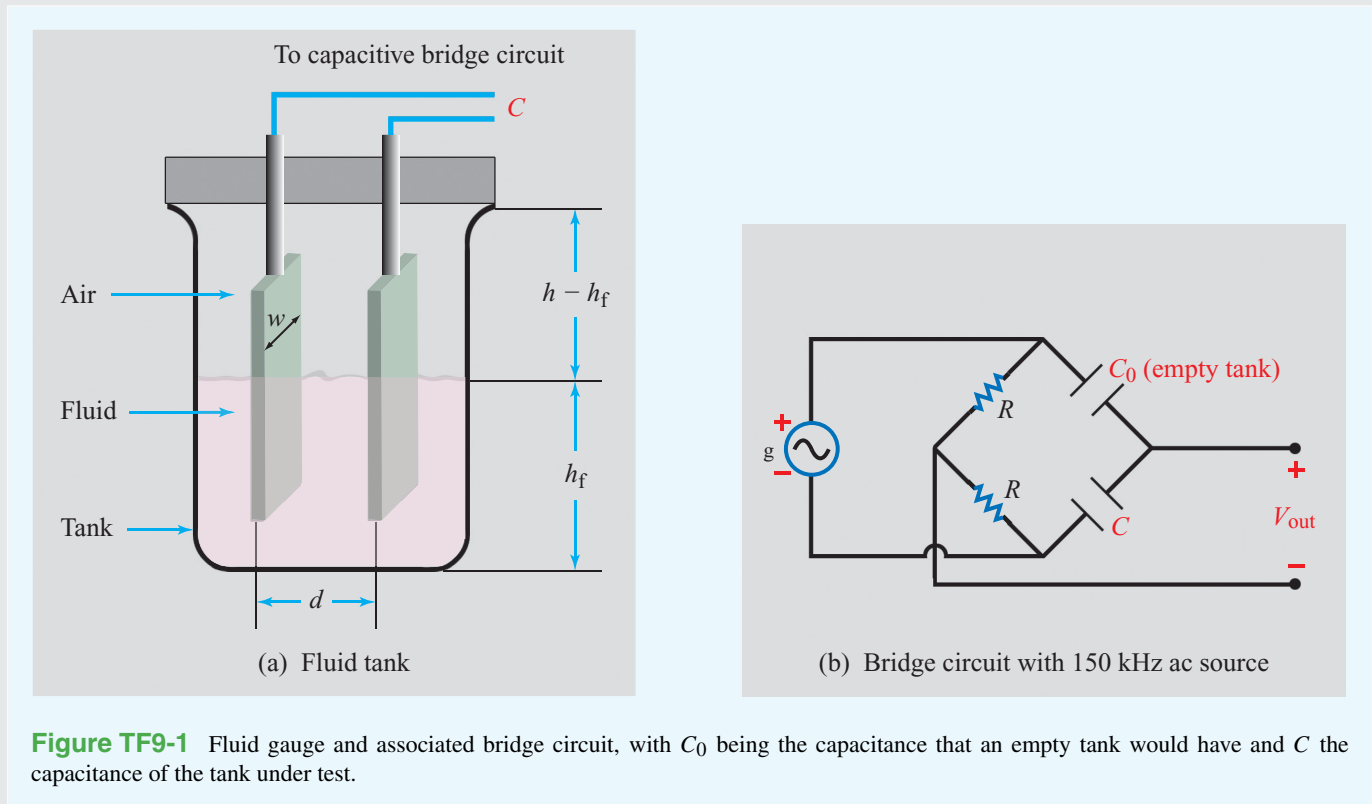
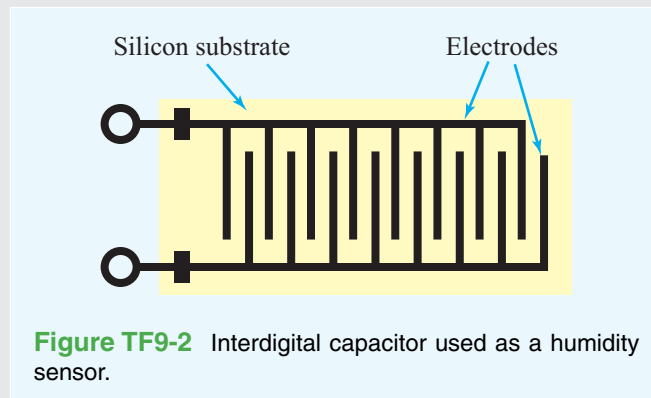

Figure TF9-1 Fluid gauge and associated bridge circuit, with C_0 being the capacitance that an empty tank would have and C the capacitance of the tank under test.



► The output voltage V_{out} assumes a functional form that depends on the source voltage v_g , the capacitance C_0 of the empty tank, and the unknown fluid height h_f . ◀

Humidity Sensor

Thin-film metal electrodes shaped in an **interdigitized pattern** (to enhance the ratio A/d) are fabricated on a silicon substrate (**Fig. TF9-2**). The spacing between digits is typically on the order of $0.2 \mu\text{m}$. *The effective permittivity of the material separating the electrodes varies with the relative humidity of the surrounding environment.* Hence, the capacitor becomes a humidity sensor.

Pressure Sensor

A flexible metal **diaphragm** separates an oil-filled chamber with reference pressure P_0 from a second chamber exposed to the gas or fluid whose pressure P is to be measured by the sensor [**Fig. TF9-3(a)**]. The membrane is sandwiched, but electrically isolated, between two conductive parallel surfaces, forming two capacitors in series (**Fig. TF9-3(b)**). When $P > P_0$, the membrane bends in the direction of the lower plate. Consequently, d_1 increases and d_2 decreases, and in turn, C_1 decreases and C_2 increases [**Fig. TF9-3(c)**]. The converse happens when $P < P_0$. With the use of a capacitance bridge circuit, such as the one in **Fig. TF9-1(b)**, the sensor can be calibrated to measure the pressure P with good precision.

Noncontact Sensors

Precision positioning is a critical ingredient in semiconductor device fabrication, as well as in the operation and control of many mechanical systems. **Noncontact capacitive sensors** are used to sense the position of silicon wafers during the deposition, etching, and cutting processes, without coming in direct contact with the wafers.

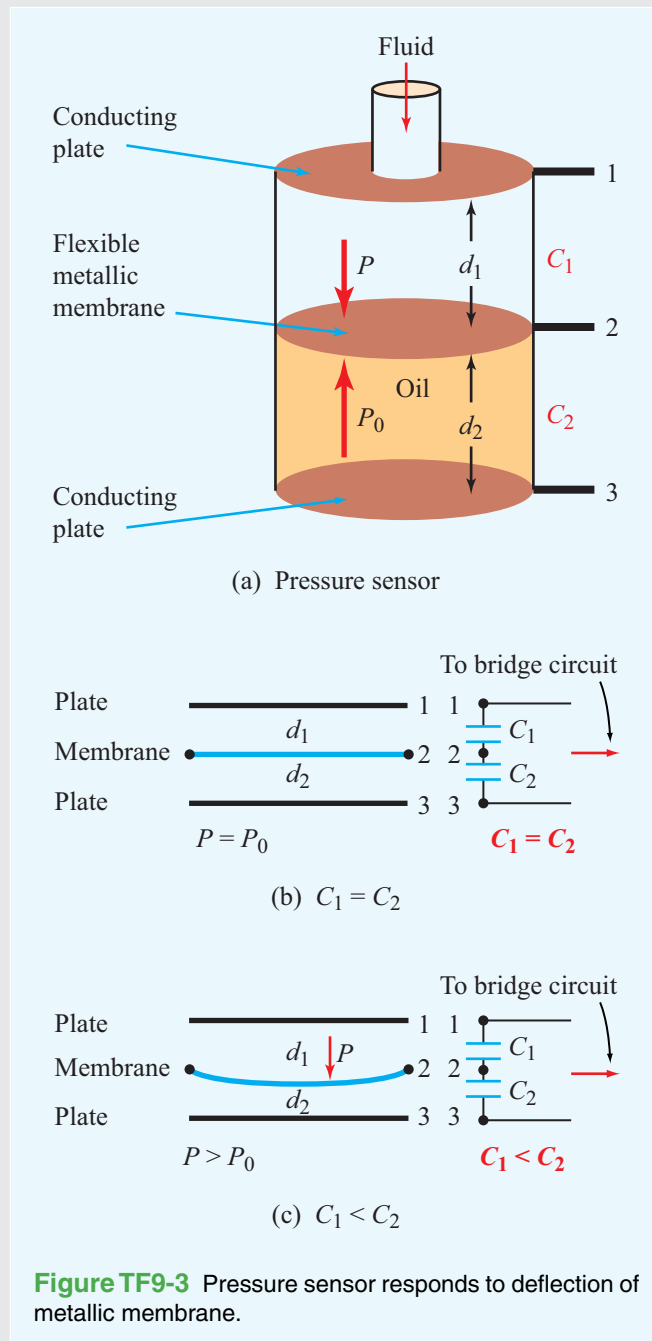
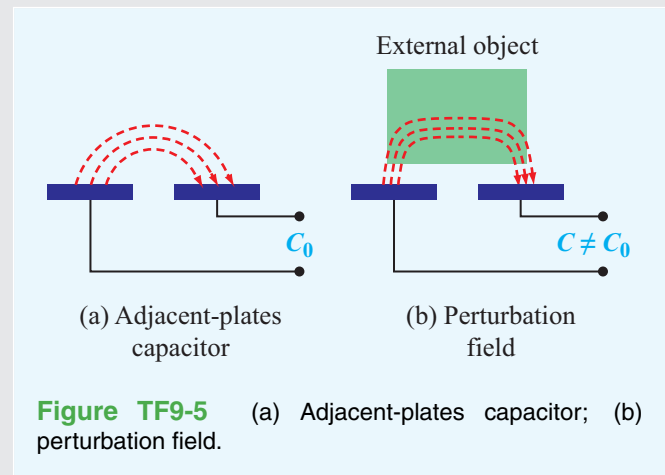
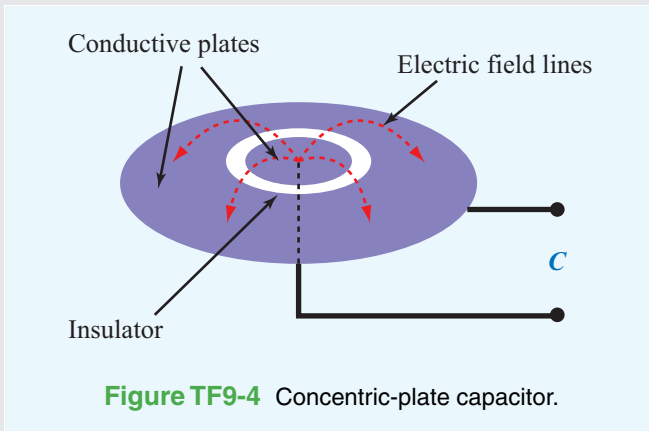

Figure TF9-3 Pressure sensor responds to deflection of metallic membrane.

► They are also used to sense and control robot arms in equipment manufacturing and to position hard disc drives, photocopier rollers, printing presses, and other similar systems. ◀



The concentric plate capacitor in **Fig. TF9-4** consists of two metal plates, sharing the same plane, but electrically isolated from each other by an insulating material. When connected to a voltage source, charges of opposite polarity form on the two plates, resulting in the creation of electric-field lines between them. The same principle applies to the adjacent-plates capacitor in **Fig. TF9-5**. In both cases, the capacitance is determined by the shapes and sizes of the conductive elements and by the effective permittivity of the dielectric medium containing the electric field lines between them. Often, the capacitor surface is covered by a thin film of nonconductive material, the purpose of which is to keep the plate surfaces clean and dust free.

► The introduction of an external object into the proximity of the capacitor [**Fig. TF9-5(b)**] changes the effective permittivity of the medium, perturbs the electric field lines, and modifies the charge distribution on the plates. ◀

This, in turn, changes the value of the capacitance as would be measured by a capacitance meter or **bridge circuit**. Hence, the capacitor becomes a **proximity sensor**, and its sensitivity depends, in part, on how different the permittivity of the external object is from that of the unperturbed medium and on whether it is or is not made of a conductive material.

Fingerprint Imager

An interesting extension of noncontact capacitive sensors is the development of a fingerprint imager consisting of a two-dimensional array of capacitive sensor cells, constructed to record an electrical representation of a fingerprint (**Fig. TF9-6**). Each sensor cell is composed of an adjacent-plates capacitor connected to a capacitance measurement circuit (**Fig. TF9-7**). The entire surface of the imager is covered by a thin layer of nonconductive oxide. When the finger is placed on the oxide surface, it perturbs the field lines of the individual sensor cells to varying degrees, depending on the distance between the ridges and valleys of the finger's surface from the sensor cells.

► Given that the dimensions of an individual sensor are on the order of $65 \mu\text{m}$ on the side, the imager is capable of recording a fingerprint image at a resolution corresponding to 400 dots per inch or better. ◀

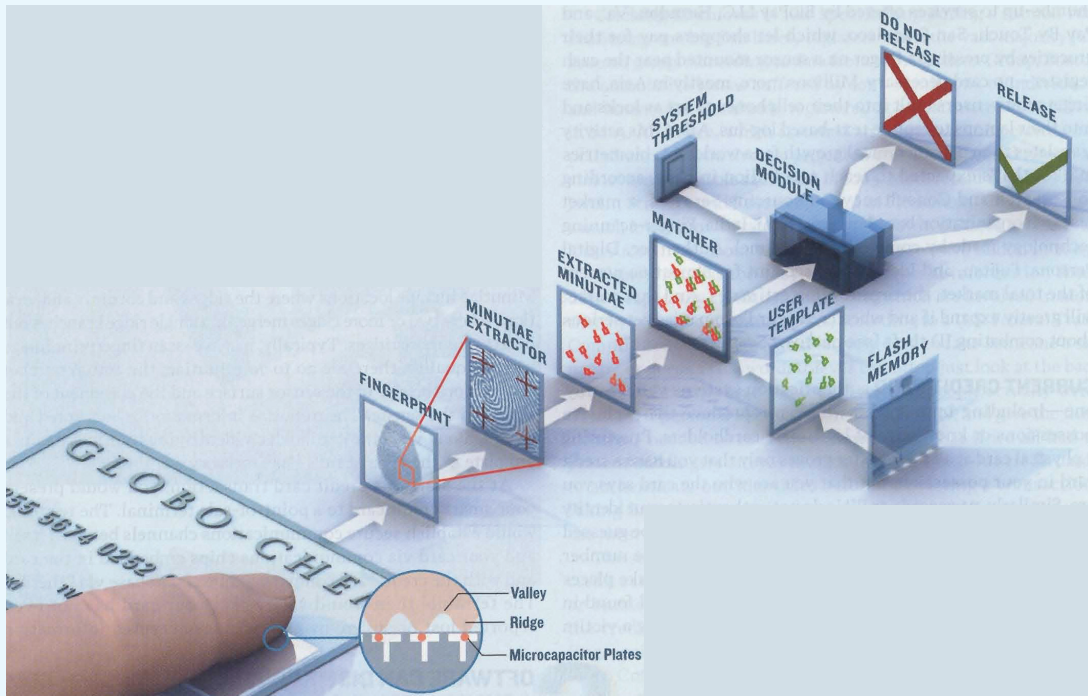

Figure TF9-6 Elements of a fingerprint matching system. (Courtesy of IEEE Spectrum.)

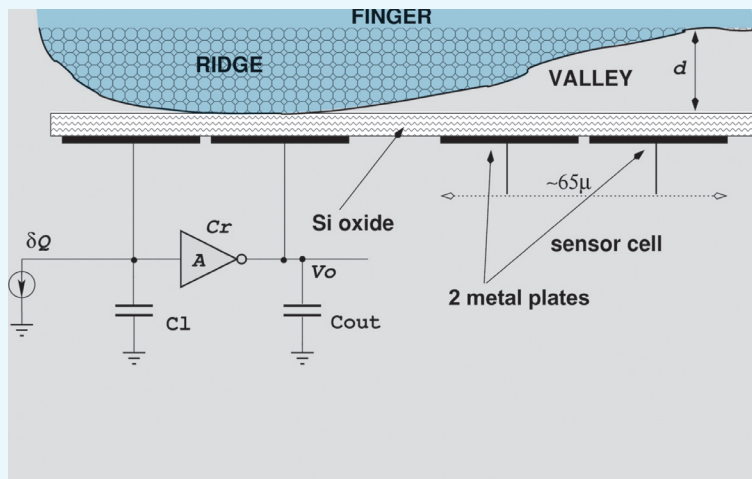

Figure TF9-7 Fingerprint representation.